

Accessible One Piece Shower 48"x36"

Submittal Information; All accessories shown are optional
Custom submittal forms completed with each order

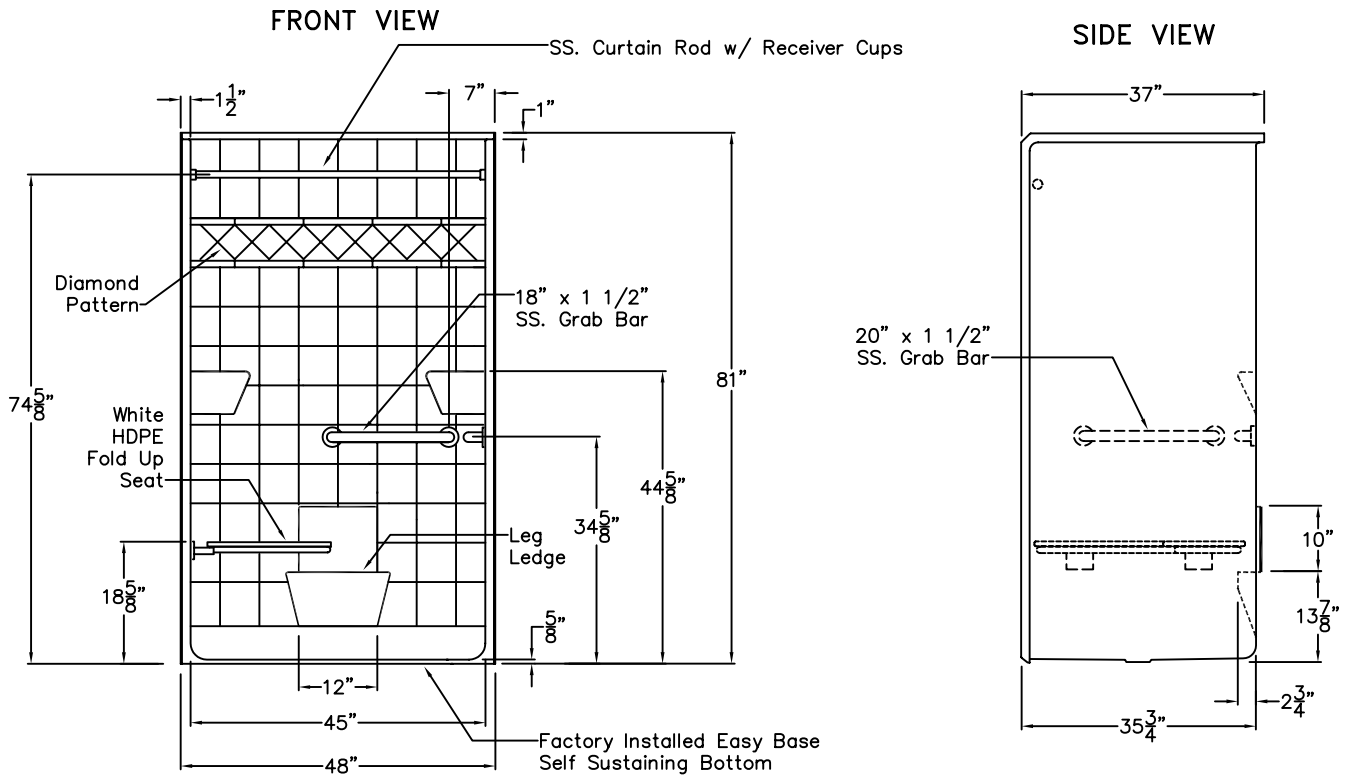

Accessible Shower Stall

The shower enclosure shall be Model APTXST4836BF5 center, right or left. Finished surface shall be of a sanitary-grade polyester Delcoat exhibiting a minimal thickness of 15 dry mils, and a finished cured Barcol hardness of 80-90 as tested with ASTM D-2583. Unit construction shall be of molded reinforced fiberglass with a 15% minimum fiberglass content. The unit shall have outside dimensions of 48" x 37" x 81". The base shall be attached to the sump of the unit in such a manner to form an integral part with an inner and outer coating of reinforced polyester resin. The unit shall meet ANSI 124.2, HUD, BOCA, NAHB, UPC, and shall meet the requirements of Southern Building Code.

The enclosure may be equipped with the following installed accessories:
1) one 18" x 1 1/2" diameter, stainless steel grab bar on the back wall, 2) one 20" x 1 1/2" stainless steel grab bar on the valve wall, both with 1 1/2" statute clearance, mounted with stainless steel bolts and secured from the rear with a 3" x 3" 11 gauge metal mounting plate, 3) factory installed white HDPE fold up seat, 4) molded soap ledges, 5) molded leg ledge, 6) tile finish, 7) diamond accents, 8) one inch diameter 18 gauge stainless steel curtain rod with receiver cups, 9) factory installed Easy Base self sustaining bottom, 5/8" threshold with Easy Base.

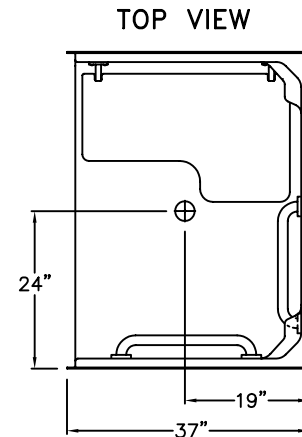

DUE TO THE NATURE OF THE MATERIALS INVOLVED, UNIT DIMENSIONS MAY VARY + 1/2 INCH.

Job Name:

Model No. APTXST4836BF5

Drawing#: APTXST4836BF5

Approved by:

Date Approved:

Date: 6-22-07

Revised: 12-12-08

Rep.:

Wholesaler:

Quote No.: